

TELESTEPS 
No.1 in telescopic work tools



AN ICONIC HISTORY.
AN INSPIRING FUTURE.



Many years ago, we created an icon in the world of ladders, and today we are recognized as the world leader in telescopic work tools.

With both R&D and world class production based in Sweden, the Telesteps brand and our products, are renowned for its quality and design, by many professional tradesmen worldwide ensuring we always put safety and quality first.

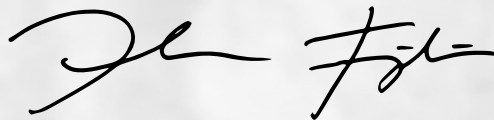
A handwritten signature in black ink, consisting of a stylized 'J' followed by 'Fräjdin'.

Johan Fräjdin, CEO Telesteps



**SAFE,
ERGONOMIC AND
EFFECTIVE.**

CONTENTS

Discover the world of Telesteps.

08 TELESCOPIC LADDERS

There are many great reasons to choose a telescopic ladder no matter if you are a professional or DIY.

10 MADE IN SWEDEN

We believe that design and quality goes hand in hand when creating safe and user friendly products.

12 SERVICE & MAINTENANCE

To be able to enjoy your Telesteps ladder for as long as possible it is important that you take good care of your ladder.

14 THE ORIGINAL

Over 30 years ago we created an icon in the world of ladders and we are still pushing the limits.

18 PRIME LINE

With Prime we took everything we know about designing quality ladders and embarked on a new era.

24 COMBI LINE

The name says it all. Combi Line is a stand alone ladder that can be used as a leaning ladder.

30 SOLID LINE

A rock solid and height adjustable workplatform that is an ease to carry and transport.

34 ECO LINE

Safe, functional and easy to carry with you – The Friend for Your Home!

38 LOFT LINE

Loft Line is a smart, user friendly ladder, delivering lots of benefits when using it.

42 RESCUE LINE

The first telescopic ladder in the world where 3 people can use the ladder at the same time.

48 ACCESSORIES

Great products become iconic with the right accessories.

53 SPARE PARTS

You will use our ladders for a long time. Very long time. This causes parts to wear out and sometimes have to be replaced.

SAFE & FLEXIBLE

For everyone and everywhere.



TELESCOPIC LADDERS

The benefits of using Telesteps telescopic ladders.

FLEXIBLE AND SAFE

When using a ladder, safety is of outmost importance. Think about the leaning angle. The leaning angle should be 75° for rungs to be even. This can sometimes be hard to achieve with a traditional ladder. Our telescopic ladders are very flexible, and you are able to adjust the height for each location, to obtain a safe leaning angle.

EASE OF TRANSPORTATION

One of the key and unique features of all our ladders, is the ease of transportation. No matter what size of car or vehicle you are using, one or several of our great ladders will always fit in your trunk!

In case you have a pickup, a station wagon or even a truck, you might even want to take all of our ladders with you, just to be sure that you are equipped for every specific task.

MORE EFFICIENT WITH ACCESSORIES

Our accessories make your everyday work easier. To further improve our products and personalize them to your specific needs, we have a number of accessories we developed for you. Our most popular one is the adjustable safety feet. A necessary accessory for you and your ladder, staying steadily in an upright position while on the ladder, even if the ground is uneven. Brilliantly, you'll be able to wash your window in your staircase, using the adjustable safety feet in combination with your Telesteps ladder. You will find all our accessories on page 48.



ADJUST TO THE PERFECT HEIGHT

Our telescopic ladders can be adjusted to the perfect height for each task. This leads to a more flexible and safer ladder at the end.



STORABLE IN EVERY CAR

The compact design of our ladders allows it to store them almost anywhere, no matter if you need it in your service vehicle or on the wall in your garage.



USE IT, EVEN IN LIMITED SPACE

There can always be occasions when you need to transport the ladder into a limited space e.g. in an elevator or a crowded area.

MADE IN SWEDEN

The art of telescopic ladders.



SWEDISH PRODUCTION

For your safety.

A fully automatic production facility has been built up, in the deep forest of Sweden. There are huge benefits, both to our customers but also to our planet, saving a great deal of CO₂ pollution.

With our dedicated team and a fully automated production, every single ladder is a perfection of each component, which perfectly fits together - Just as a high-quality wristwatch. We are in full control of the production from the first piece of raw aluminum to the final assembled ladder, and of course full traceability of each component.

To have the world's first fully automatic production of telescopic ladders based in Sweden makes us, in humbled way, very proud.

EVEN BETTER QUALITY

The new fully automatized manufacturing in Sweden ensures a repetitive quality for every single ladder to the highest of standards! The whole process is performed by high-precision equipment supervised by the quality-assurance team.

With the production located in Sweden, with continuous innovations – the heart & soul of our company - will reach the market faster than ever. Due to the regional proximity, R&D and manufacturing will work together even closer which accelerates this important process in great fashion!



DESIGN

Not just for looks.

Professionals all around the world appreciate our products unique appearance, feeling almost exclusive, professional, but more importantly SAFE. Telesteps, a product from professionals to professionals.

Design is a result of great engineering and every small component is created for a reason of safety, comfort or ease of use.

Let's navigate you through a couple of examples and show you details of how a part of great engineering contributes and creates an amazing product.

- Our patented triangular tube shape is stronger than the traditional round tube. We have also enhanced the corners of the aluminium tube where the external impact is as strongest. The triangular shape also creates a perfect grip when climbing the ladder.
- Our angled brackets are generating level rungs. At a first glance, this might not be a big deal but once you stand on our level and wide rungs you do not want to go back to the traditional ones. Wide and level rungs make it a lot more comfortable standing on the ladder, but most of all, it is safer, and the risk of slipping is almost eliminated.

SERVICE & MAINTENANCE

Something important.



BE SAFE BY TAKING CARE OF YOUR PRODUCT!

For reasons of safety and functionality, the telescopic product must always be kept clean, particularly the tubes and rungs. Dirt, filings, paint spots, glue etc. recommended to be cleaned after each use, and before the ladder is closed. If your ladder is soaking wet, fully extend the ladder, wipe off and keep it extended until the ladder is completely dry.

The ladder is not safe if any of the parts are damaged or worn out. Don't use the ladder if needs to be repaired. Replace damaged parts or/and contact your authorized service workshop for assistance. Any repair work must always be carried out by an authorized service workshop.

Treat your Telesteps Products with care and it will retain its unique properties. Follow strictly recommendations and steps, to always have a safe product ready for your daily challenges.

BEFORE USE – AFTER USE – YEARLY INSPECTION



THE ORIGINAL

Since beginning, we have been leading the telescopic ladder industry.



FIRST, BEST & SAFEST

A smart patent, making safety as the highest priority, has positioned Telesteps as the clear market-leader in the World. The interest keeps growing for our telescopic ladders and work platforms.

As the original founder and developer of the products, we clearly possess the longest and widest experience of how to manufacture a safe quality telescopic ladder. We are proud of our culture, where we never compromise on safety or quality. We don't just know how to make a good ladder – we ensure each component is tested, both individually and together in a working unit before delivery.

Being first with a product that changed the market in one blow, means we are being observed. Many of the advantages and safety features can be found there. In this case, the Original has been tested and certified in accordance with the standards of independent parties.





PRODUCT LINES

We are offering a wide range of telescopic ladders to match your everyday need. The products can be equipped with different accessories to make your workday even more pleasant and effective.





24



SOLID LINE

30



RESCUE LINE

42



ACCESSORIES

48

PRIME LINE

The most powerful telescopic ladder yet.



ACCESS MADE SAFE

The most powerful telescopic ladder yet.

Innovation runs in our veins and every time we develop a new product or further improve our existing products, we put safety first. During the last 25 years we have gathered a lot of experience and expertise. When we created the Prime Line we took everything we have learned over the years and implemented it into this unique access tool.

AS GOOD AS IT GETS

With Prime Line you will get an extremely practical ladder that is easy to use and a pleasure to work with. We are the first and only ladder company in the world to develop level rungs, our 80 mm wide and level rungs will minimize slipping and reduce fatigue making it more comfortable when working on a ladder for longer periods of time.

Due to its compact size Prime Line is both easy to transport in almost any vehicle and just as comfortable to bring to any working area, no matter if it is a tight space or if you need an elevator to get there. Once there, you can easily adjust the height of the ladder to perfectly fit your needs.



SAFETY FEATURES

We did not just build a great and extremely practical ladder, but our first priority was to make it safe. Prime was the first telescopic ladder with our patented triangular tube design. The brilliantly engineered triangular shape makes the ladder more twist resistant and stronger than ever before. But that is not all, Prime Line has a lot of innovating details making it as safe as possible. To just name a few, the angled rubber feet are creating maximum surface contact, the red safety tabs ensure every rung is locked before you use the ladder and the rubber tops prevents the ladder from sliding and is avoiding wall damages at the same time.

With Prime, we took everything we know about designing quality ladders and embarked on a new era. This is where safety, quality, and design meets.



IT'S ALL IN THE DETAILS

A ladder is a ladder they say. But we know that it is the small details creating the big difference.

RUBBER TOP SECTION

Works individually on uneven surfaces.
Avoids sliding and damaging walls.



ADJUSTABLE HEIGHT

Extend only to your desired height.



ERGONOMIC

Wide and level rungs to minimize slipping and reduce fatigue.



SAFER RUNGS

Rungs with grooved channels to disperse dirt.



A STRONG TRIANGULAR DESIGN

Twist and flex resistant by nature
U.S. Patent No. Des. US D683,479 S



SLOW CLOSE SYSTEM

Controlled closing to avoid pinching fingers.



SAFE LOCKING

Red indicator tabs to ensure your safety every time.



SMART & SAFE UNLOCKING

Two push buttons for closing the ladder.
Autostep® - Automatic unlocking system when closing the ladder.

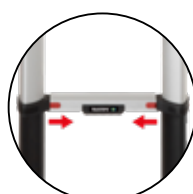

ANGLED RUBBER FEET

Maximum surface contact to avoid slipping.

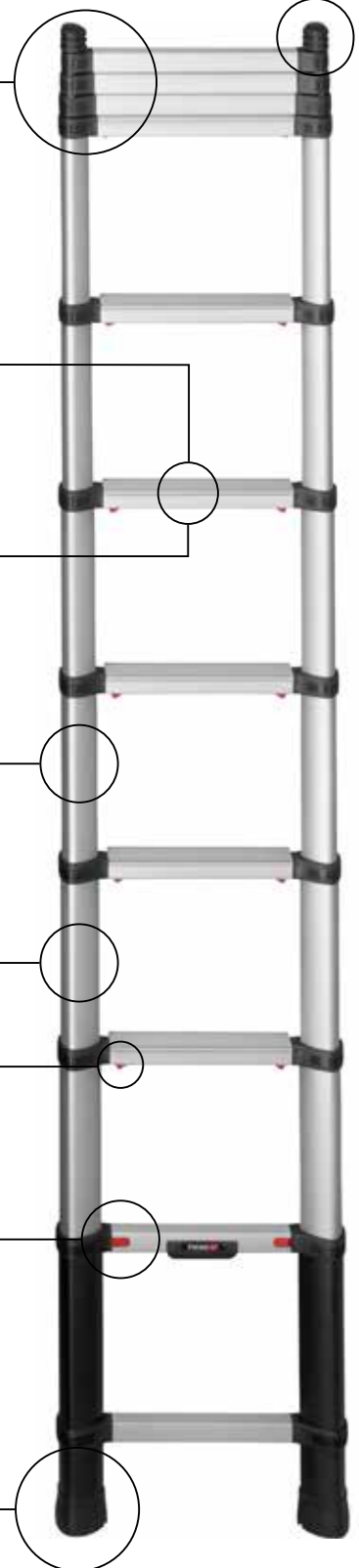

CHOOSE THE RIGHT ONE

Our Prime Line is available in four different heights.

Depending on your usage we recommend different ladders. At what working height will you use the ladder? If you need to reach a working height of 5 meters, then the 4,1 meter is the one for you. A full range ladder which gives you maximum flexibility with the highest working height. How often will you use the ladder? If you are using it more frequently and mostly indoors the best choice might be our 2,6 and 3,0 meters as they are the most lightweight.



PRIME LINE 2,6 M

Art. no.	72226-541
No. of treads	8
Tread width	40 mm
Working height	3,4 m
Length, extended	2,6 m
Length, closed	0,72 m
Width	0,45 m
Weight	8,0 kg



PRIME LINE 3,0 M

Art. no.	72230-581
No. of treads	9
Tread width	80 mm
Working height	3,8 m
Length, extended	3,0 m
Length, closed	0,76 m
Width	0,47 m
Weight	10,2 kg



PRIME LINE 3,5 M S

Art. no.	72235-781
No. of treads	11
Tread width	80 mm
Working height	4,3 m
Length, extended	3,5 m
Length, closed	0,87 m
Width	0,55 m
Weight	15,2 kg



PRIME LINE 3,5 M SB

Art. no.	72235-681
No. of treads	11
Tread width	80 mm
Working height	4,3 m
Length, extended	3,5 m
Length, closed	0,87 m
Width	0,86 m
Weight	14,7 kg



PRIME LINE 4,1 M S

Art. no.	72241-781
No. of treads	13
Tread width	80 mm
Working height	4,9 m
Length, extended	4,1 m
Length, closed	0,93 m
Width	0,56 m
Weight	17,4 kg



PRIME LINE 4,1 M SB

Art. no.	72241-681
No. of treads	13
Tread width	80 mm
Working height	4,9 m
Length, extended	4,1 m
Length, closed	0,94 m
Width	0,9 m
Weight	16,7 kg



ACCESSORIES

Our accessories will facilitate your daily work.

To further improve our products and personalize them to your specific needs we are offering a number of accessories to choose from.



ADJUSTABLE SAFETY FEET

No matter where you're putting your ladder, you'll have a safe position standing on the ladder, no matter of any uneven surfaces and grounds, or any staircases.

Read more on page 50



GROUND SPIKES

The base doesn't matter – snow, mud or dirt. Better grip is always close at hand. This accessory is a complement to our Safety Foot and works safely even in the most extreme climates.

Read more on page 50



TOOL TRAY

This small but handy accessory allows you to place tools, screws, electrical instruments and other equipment on a practical tray while you are working.

Read more on page 49



WALL MOUNT

With Telesteps helpful wall mount, you can be sure to find your ladder at the same place each time – without taking up space.

Read more on page 49



CARRY BAG

Nice and robust bag to carry the ladder in. It also protects the ladder.

Read more on page 51



MAINTENANCE KIT

To even extend the functionality and secure the safety of your ladder we have created a maintenance kit including a cleaning sponge and a microfiber towel.

Read more on page 51



ROOF CONNECTOR

At your home or a place where you regularly climb the ladder our Roof Connector will keep the ladder safely in place.

Read more on page 52



SPARE PARTS

Our high quality makes the products last a long time. Very long time. This might cause parts to wear out and sometimes have to be replaced.

Read more on page 53



COMBI LINE

Freestanding or leaning, you decide.

THREE IS BETTER THAN ONE

Free standing, A-frame and leaning telescopic ladder, all in one.

Our Combi Line is exactly what it is called, a free-standing ladder fully extended for the highest working height, but which, at limited height, can be used as an A-ladder, to be easily changed and used like a leaning ladder. For this reason, Combi Line is the ideal choice when you need a multi-purpose ladder for all different types of situations.

ERGONOMIC AND SAFE

To be and feel safe on a ladder is our highest priority, therefore we have implemented a lot of safety features. The red tabs are a clear indicator when the rungs are locked and safe to climb. Our new 80 mm wide and level rungs with grooved channels provide you with great grip and are very comfortable to stand on even for longer periods of time.

The patented triangular tubes are providing the ladder with strength and making it more flex resistant thanks to our engineering. The shape does also create a perfect grip when climbing the ladder. Like all our ladders Combi Line is equipped with both rubber tops and feet all to avoid slipping.

FLEXIBLE AND EASY TO USE

The very nature of our telescopic ladders allows them to be easily transported in almost any vehicle. The ladders are convenient carrying around at the working site, even when you need to use an elevator or there is lack of space.

The newly developed Autolift makes it even easier to carry Combi Line, especially when you often move the ladder during your workday.

In just a couple of seconds you can transform Combi Line from a free-standing ladder into a leaning ladder. Just push the buttons on the back side of the ladder and pull the bottom rungs upwards until you can attach our Easy Lock to the above rung. Done.

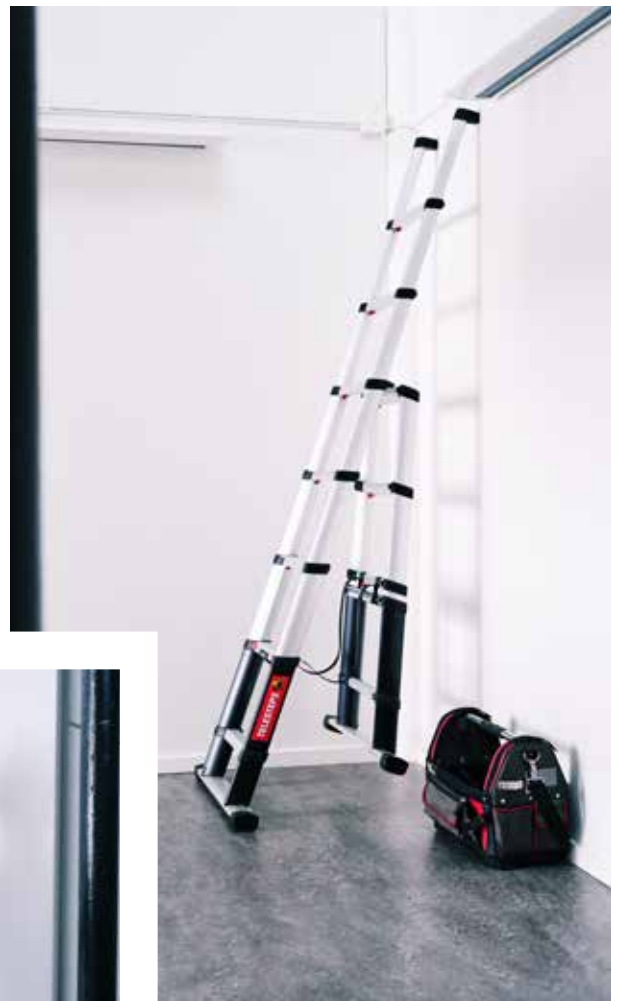

IT'S ALL IN THE DETAILS

A ladder is a ladder they say. But we know that it is the small details creating the big difference.

SAFE LOCKING

Red indicator tabs to ensure your safety every time.



ERGONOMIC

Wide and level rungs to minimize slipping and reduce fatigue.



SAFER RUNGS

Rungs with grooved channels to disperse dirt.



INTEGRATED HANDLE

The Combi Line has an integrated handle making it very easy to carry.



RUBBER FEET

Maximizing surface contact to avoid slipping.

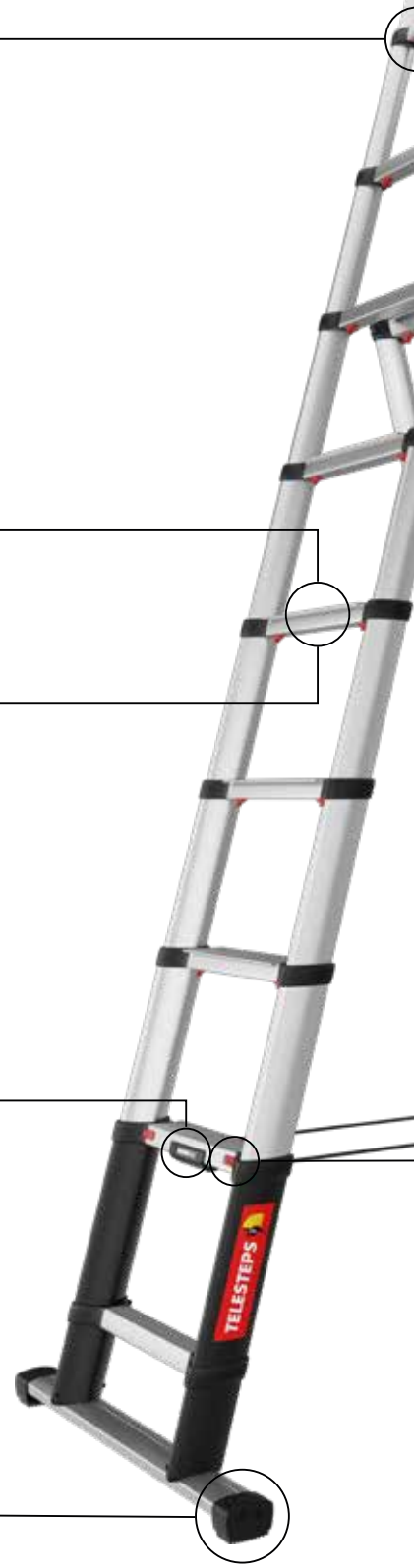
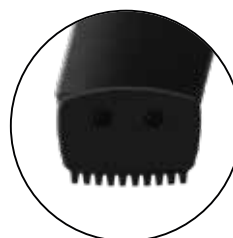

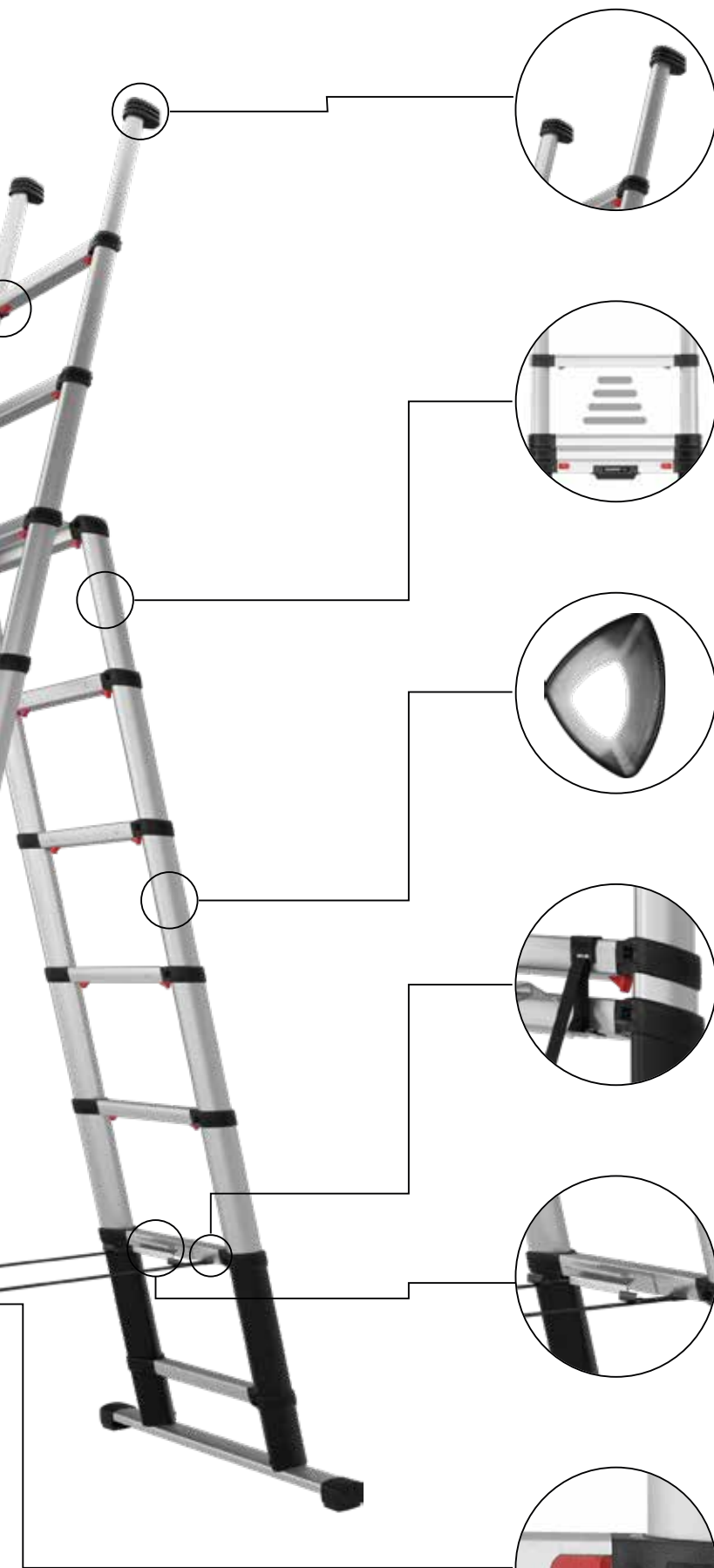

RUBBER TOP SECTION

Works individually on uneven surfaces.
Avoids sliding and damaging walls.



SLOW CLOSE SYSTEM

Controlled closing to avoid
pinching fingers.

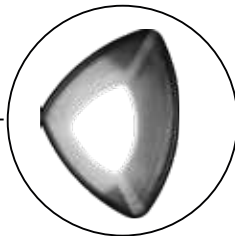

TRIANGULAR DESIGN

Twist and flex resistant by nature.



EASY LOCK

Two ladders in one – Easy to
transform from a standing ladder
to a leaning ladder.

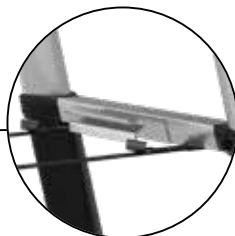

AUTOLIFT

Connecting front and back side of
the ladder, when lifting.

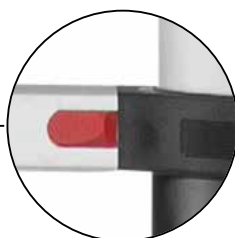

SMART & SAFE UNLOCKING

Two push buttons for closing the ladder.
Autostep® - Automatic unlocking
system when closing the ladder.



CHOOSE THE RIGHT ONE

Our Combi Line is available in two different heights.



COMBI LINE 2,3

Art. No.	72423-681
Tread width	80 mm
Working height	3,1 m
Length, closed	0,73 m
Width	0,68 m
Weight	14,1 kg
Max load	150 kg
Max users	1

COMBI LINE 3,0

Art. No.	72430-681
Tread width	80 mm
Working height	3,8 m
Length, closed	0,79 m
Width	0,75 m
Weight	19,5
Max load	150 kg
Max users	1

ACCESSORIES

Our accessories will facilitate your daily work.

To further improve our products and personalize them to your specific needs we are offering a number of accessories to choose from.



TOOL TRAY

This small but handy accessory allows you to place tools, screws, electrical instruments and other equipment on a practical tray while you are working.

[Read more on page 49](#)



WALL MOUNT

The perfect wall mount to store and keep your Telesteps ladder safe. With Telesteps stylish wall mount, you can be sure to find your ladder at the same place each time – without taking up space.

[Read more on page 49](#)



MAINTENANCE KIT

To even extend the functionality and secure the safety of your ladder we have created a maintenance kit including a cleaning sponge and a microfiber towel.

[Read more on page 51](#)



SPARE PARTS

Our high quality ensures a long lasting product. Very long lasting. This might cause parts to wear out and sometimes have to be replaced.

[Read more on page 53](#)



SOLID PLATFORM

SOLID LINE

The Steadiest Surface Since The Ground.

STEADY AS A ROCK

Your perfect friend when you work for longer periods of time.

The Solid platform can be adjusted to the ideal height fitting all your needs. It is small and compact for storage as well as transportation and with its telescopic function the platform is perfect for narrow spaces. Our new upgraded version has a reinforced framework which makes it even more stable and torsional rigid.



SAFETY FEATURES

A simple & safe locking system, wide steps for a comfortable experience and a built-in handle for easy carrying combined do result in a perfect work tool which is designed for tough work environments. The ideal platform for people working on the same area over an extended period of time.

The steadiest and most agile platform you will ever use.



IT'S ALL IN THE DETAILS

A ladder is a ladder they say. But we know that it is the small details creating the big difference.



SMART & SAFE UNLOCKING
Two push buttons for closing the ladder.

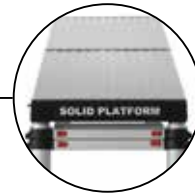

WIDE STANDING AREA
Wide area to stand on. Can also be used as a working table.



SAFER RUNGS
Rungs with grooved channels to disperse dirt.



ADJUSTABLE HEIGHT
Extend only to your desired height.



RUBBER FEET
Rubber feet to avoid damaging the floor surface.



BUILT-IN HANDLE
A clever handle making it easy to carry the ladder.

ALL IT TAKES IS ONE

Our Solid Line. A flexible and versatile platform.



SOLID LINE

Art. No.	61209-601
Tread width	65 mm
Working height	2,6 m
Height, extended	0,51 / 0,68 / 0,88 m
Size, closed	0,74 x 0,28 x 0,62 m
Weight	16,5 kg
Max load	150 kg
Max users	1



ACCESSORIES



MAINTENANCE KIT

To even extend the functionality and secure the safety of your ladder we have created a maintenance kit including a cleaning sponge and a microfiber towel.

Read more on page 51



SPARE PARTS

Our high quality makes the products last a long time. Very long time. This might causes parts to wear out and sometimes have to be replaced.

Read more on page 53

ECO LINE

For Homeowners and DIY.



PERFECT FOR HOMEOWNERS

A practical ladder that gets the job done.

Simple locking system with only two buttons. Big and small, yet simple and user friendly to handle with no compromise in quality or safety. The Eco Line has its elegant air-damping system built in to minimize squeezing fingers and for a controlled closing of the ladder. It is not only safe but makes the ladder easier to use at the same time.

Safe, functional and easy to carry with you – The Friend for Your Home!



SAFETY FEATURES

Eco Line is equipped with a simple and safe unlocking system. The air-damping system inside the tubes, is preventing your fingers from being pinched.

The rungs are equipped with friction profiles to minimize risk of slipping.

Eco Line is made of high-quality anodized aluminum with glass fiber reinforced plastic fittings and is also EN 131 and SP (RISE) certified.



IT'S ALL IN THE DETAILS

A ladder is a ladder they say. But we know that it is the small details creating the big difference.

RUBBER TOP SECTION
Avoids sliding and damaging walls.



ADJUSTABLE HEIGHT
Extend only to your desired height.



SAFE RUNGS
Rungs with grooved channels to disperse dirt.



AIR-DAMPING SYSTEM
Controlled closing to avoid pinching fingers.

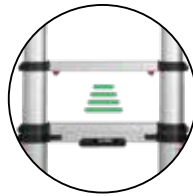

SAFE LOCKING
Red indicator tabs to ensure your safety every time.

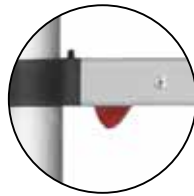

SMART & SAFE UNLOCKING
Two push buttons for closing the ladder. Autostep® - Automatic unlocking system when closing the ladder.

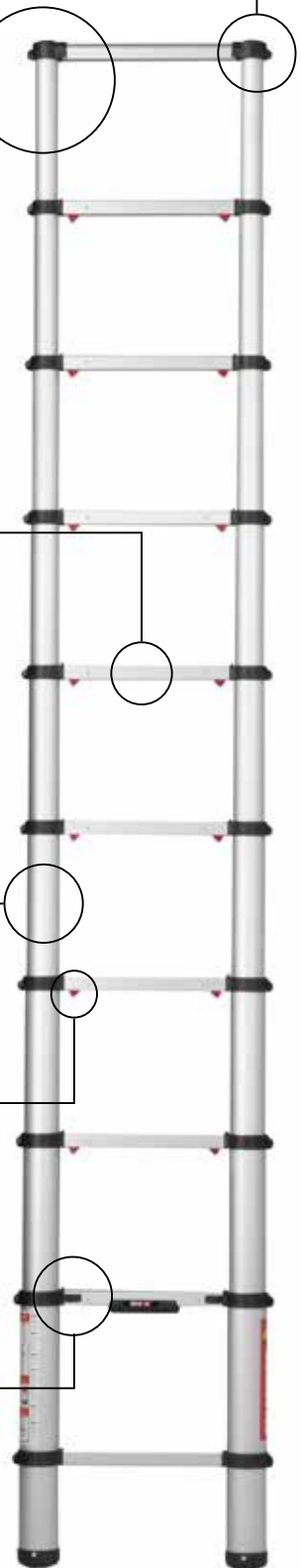
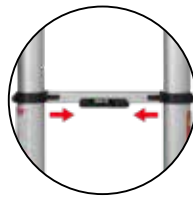

CHOOSE THE RIGHT ONE

Our Eco Line is available in two different heights.

Depending on your usage we recommend different ladders. At what working height will you use the ladder? If you need to reach a working height of 4,6 meters then the 3,8 meter is the one for you.



ECO LINE 3,0 M

Art. no.	20130-501
No. of treads	9
Tread width	40 mm
Working height	3,8 m
Length, extended	3,0 m
Length, closed	0,75 m
Width	0,5 m
Weight	9,9 kg



ECO LINE 3,8 M

Art. no.	20138-601
No. of treads	12
Tread width	40 mm
Working height	4,6 m
Length, extended	3,8 m
Length, closed	0,93 m
Width	0,91 m
Weight	15,3 kg

ACCESSORIES



CARRY BAG

Nice and robust bag to carry the ladder in. It also protects the ladder.

Read more on page 51



MAINTENANCE KIT

To even extend the functionality and secure the safety of your ladder we have created a maintenance kit including a cleaning sponge and a microfiber towel.

Read more on page 51



ROOF CONNECTOR

At your home or a place where you regularly climb the ladder our Roof Connector will keep the ladder safely in place.

Read more on page 52



LOFT LINE

How it should feel entering your loft.

THE EASY WAY TO YOUR LOFT

Loft Line is a standalone product, assembled in your existing loft framework.

When we developed the new Loft Line our ambition was to create a safer ladder, easier to install and even straightforward to use. This is the world's best telescopic Loft ladder in any aspects.

SAFETY FEATURES

When it comes to creating ladders, safety is our top priority and Loft Line is no exception. Loft Line is equipped with the same safety features as all our ladders, including safety tabs, wide and level steps, angled rubber feet and safe opening with our unique break technology.

Also, Loft Line is now produced with our patented triangular tube, making it stronger and even more impact resistant. The triangular shape also creates the perfect grip for your hand when climbing up and down the ladder.

EASIER TO USE

Loft Line is extremely convenient to use, just lift it of the frame and pull the ladder out in its fully open position. When you are done, it is just as easy to fold since it is equipped with Autostep®. Push the two buttons on the bottom rung and the ladder will easily unlock itself while you push and hook it on.



INSTALL WITH EASE

We have also updated how to install the ladder, making it easier with new features like top buttons on the MAXI for extending the top tubes. Of course, you are getting assembly guidance from our updated assembly instruction.



IT'S ALL IN THE DETAILS

A ladder is a ladder they say. But we know that it is the small details creating the big difference.

FLEXIBLE SOLUTION

Loft Line is a standalone product, assembled in your existing framework.



ADJUSTABLE HEIGHT

Loft Maxi is designed with a flexible height adjustment to obtain a safe leaning angle.



SAFE LOCKING

Red indicator tabs to ensure your safety every time.



TRIANGULAR DESIGN

Grip-friendly design that is twist and flex resistant by nature.

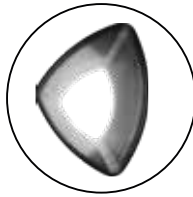

SAFE & ERGONOMIC RUNGS

Wide and level rungs with grooved channels to minimize slipping.



SAFE OPENING SYSTEM

Breaksystem to create a smooth and controlled opening.



SMART & SAFE UNLOCKING

Two push buttons for closing the ladder. Autostep® - Automatic unlocking system when closing the ladder.

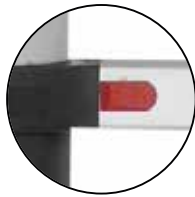

ANGELED RUBBER FEET

Maximizing surface contact to the floor.

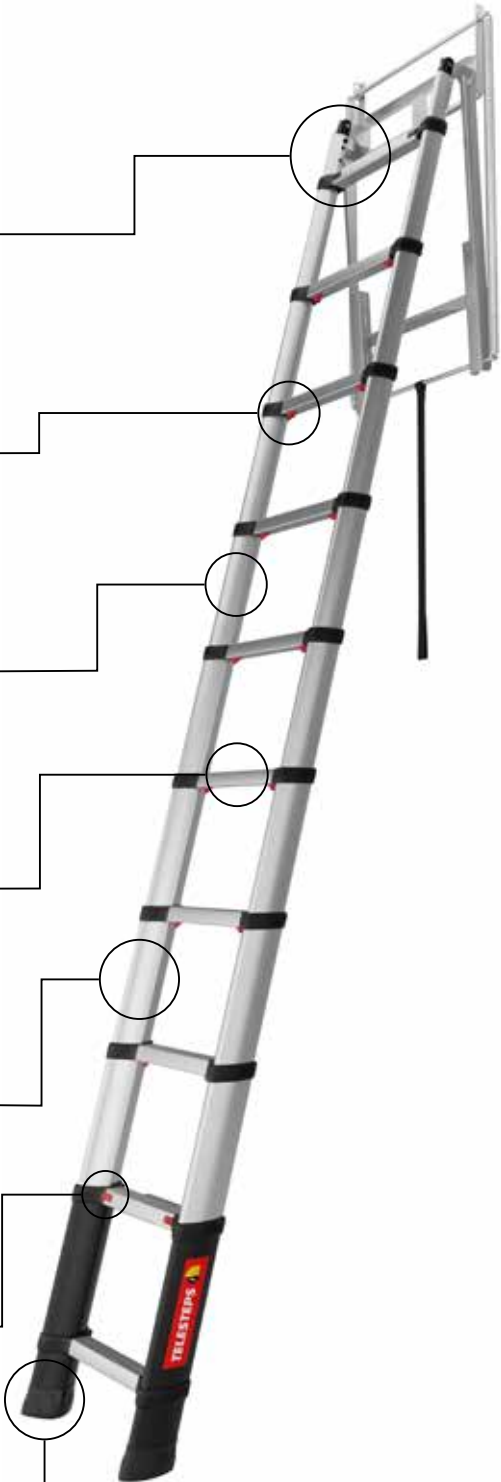
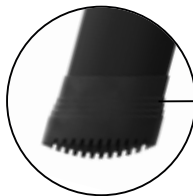

CHOOSE THE RIGHT ONE

Our Loft Line is available in two versions.

There are two main measurements that will determine which Loft Line is the right one for you. First of all, the height from the floor to the bottom of the ladder support and the second one is how big your hatch is. Look below and find your next loft ladder.

MINI 9

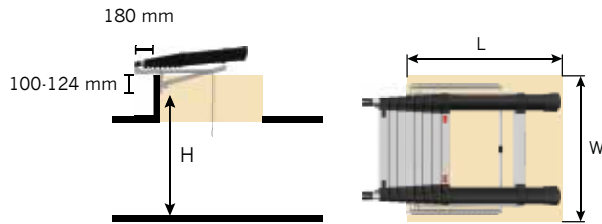

	MINI 9
Art. no.	72324-541
No. of treads	9
Tread width	40 mm
Weight	15,3 kg

MINI 9		
H (mm)	W (mm)	L (mm)
2250 - 2450	520	600

H = Floor to bottom of ladder support
W/L = Minimum inside measurement
Hatch not included



MAXI 10

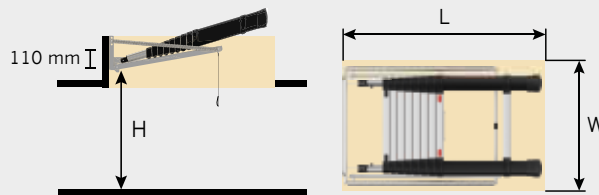

	MAXI 10
Art. no.	72527-541
No. of treads	10
Tread width	40 mm
Weight	16,6 kg

MAXI 10		
H (mm)	W (mm)	L (mm)
2800 - 2950	520	1 100
2650 - 2800	520	1 000
2550 - 2650	520	920

H = Floor to bottom of ladder support
W/L = Minimum inside measurement
Hatch not included

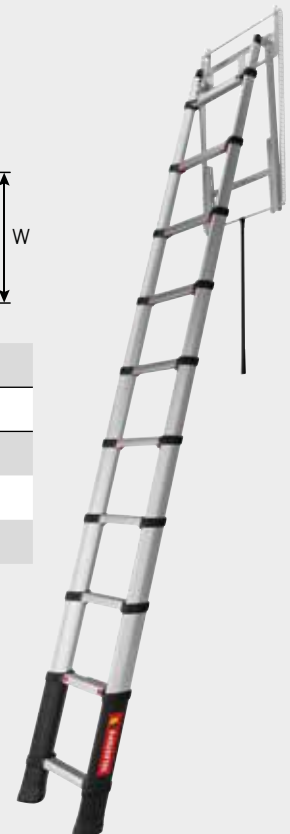

RESCUE LINE

Designed to save lives.



RESCUE IS ON ITS WAY

500 kg. The reason why this telescopic rescue ladder is unique.

Telesteps Rescue Line is the first telescopic ladder in the world for the use of three people at the same time. It is the 2nd generation with the revolutionary triangular tube design. This makes the ladder stronger and more torsional rigid than ever before.

When Telesteps created the Rescue ladder we needed to consider the various environments for rescue personnel worldwide. The Rescue Line is specifically designed for these diverse purposes.

EN 1147

The Rescue Line is certified according to the European standard EN 1147, specifically developed for fire- and rescue workers, which is one of the hardest certifications to obtain for a telescopic ladder. This means it can bear loads up to 500 kg or 3 people at the same time.



IT'S ALL IN THE DETAILS

A ladder is a ladder they say. But we know that it is the small details creating the big difference.

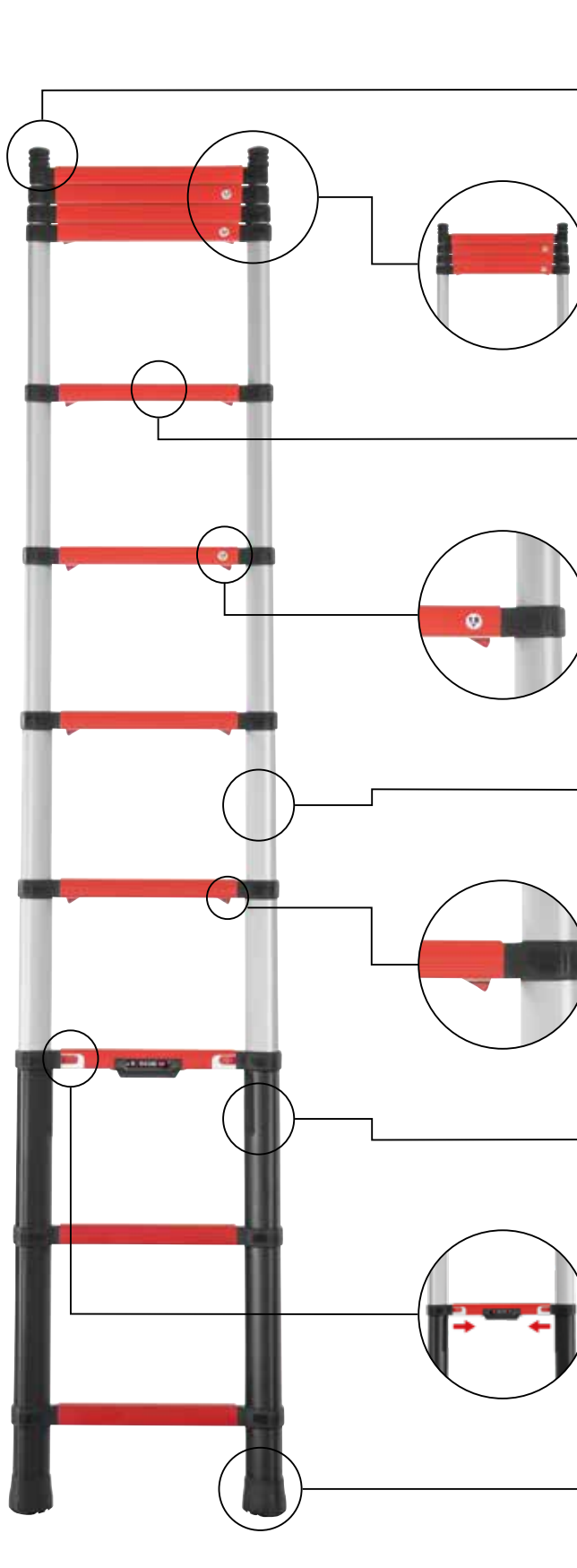

RUBBER TOP SECTION
Works individually on uneven surfaces.
Avoids sliding and damaging walls.

ADJUSTABLE HEIGHT
Extend only to your desired height.

ERGONOMIC
Wide and level rungs with rung covers to minimize slipping and reduce fatigue.

HEIGHT INDICATORS
Instantly open to desired height.

A STRONG TRIANGULAR DESIGN
Twist and flex resistant by nature.

SAFE LOCKING
Red indicator tabs to ensure your safety every time.

SECURE HANDGRIP
Built in handle for safe and quick rescue operations.

SMART & SAFE UNLOCKING
Two push buttons for closing the ladder.
Autostep® - Automatic unlocking system when closing the ladder.

ANGLED RUBBER FEET
Maximum surface contact to avoid slipping.

CHOOSE THE RIGHT ONE

Our Rescue Line is available in two different heights.

Depending on the purpose of the Rescue Line we have four different options to choose from. The ladder is available in two different sizes: 3,5 and 4,1 meters. Further on, each size is available in red, intended for rescue operations, and black, intended for police and military forces.



RESCUE LINE 3,5 M, FIREFIGHTER

Art. No.	72735-521
Tread width	50 mm
Working height	4,3 m
Length, closed	1,12 m
Width	0,47 m
Weight	15,0 kg
Max load	500 kg
Max users	3



RESCUE LINE 3,5 M, POLICE/MILITARY

Art. No.	72735-521B
Tread width	50 mm
Working height	4,3 m
Length, closed	1,12 m
Width	0,47 m
Weight	15,0 kg
Max load	500 kg
Max users	3



RESCUE LINE 4,1 M, FIREFIGHTER

Art. No.	72741-521
Tread width	50 mm
Working height	5,0 m
Length, closed	1,17 m
Width	0,47 m
Weight	19,2 kg
Max load	500 kg
Max users	3



RESCUE LINE 4,1 M, POLICE/MILITARY

Art. No.	72741-521B
Tread width	50 mm
Working height	5,0 m
Length, closed	1,17 m
Width	0,47 m
Weight	19,2 kg
Max load	500 kg
Max users	3



ACCESSORIES

Our accessories will facilitate your daily work.

To further improve our products and personalize them to your specific needs we are offering a number of accessories to choose from.



ADJUSTABLE SAFETY FEET

No matter where you're putting your ladder, you'll have full contact with the ground when you use our safety feet.

[Read more on page 50](#)



GROUND SPIKES

The base doesn't matter – snow, mud or dirt. Better grip is always close at hand.

[Read more on page 50](#)



MAINTENANCE KIT

To even extend the functionality and secure the safety of your ladder we have created a maintenance kit including a cleaning sponge and a microfiber towel.

[Read more on page 51](#)



WALL MOUNT

With Telesteps stylish wall mount, you can be sure to find your ladder at the same place each time – without taking up space.

[Read more on page 49](#)



CARRY BAG

Nice and robust bag to carry the ladder in. It also protects the ladder.

[Read more on page 51](#)



SPARE PARTS

Our high quality makes the products last a long time. Very long time. This might causes parts to wear out and sometimes have to be replaced.

[Read more on page 53](#)

ACCESSORIES

Designed to make your day safe and effective.



TOOL TRAY

A helping hand when you need it the most.

We have all been there, standing on the ladder holding screws in our mouth, all to be able to work with both hands free. Remember yourself running up and down the ladder for tools required, but not being able to be held at the same time. With Telesteps Tool Tray you are safe, avoiding unnecessary movements.

This small but handy accessory allows you to place tools, screws, electrical instruments, and other equipment on a practical tray while you are working. This way you will have both hands free and your work is easier/safer since all you need is within reach.

Its clever design allows you to easily move the Tool Tray to any one of the top three rungs without screwing. At the same time, the open sides are simplifying the cleaning before you are closing the ladder.

The compact design also allows you to fold the ladder without removing the Tool Tray, this way you will always have the tray with you when you need it.



Art. No.	9202-101
Dimensions	300x80x85 mm
Weight	0,2 kg



WALL MOUNT

Your ladder. Nice, robust and safe.

The perfect wall mount to store and keep your Telesteps ladder safe. With Telesteps helpful wall mount, you can be sure to find your ladder at the same place each time – without taking up space. The Wall Mount is available both with and without locking mechanism.

Art. No.	9195-101 (Prime Line Base)
	9195-201 (Prime Line Keylock)
	9195-601 (Combi Line Base)
Weight	1,8 kg

ADJUSTABLE SAFETY FEET

With our Adjustable Safety Feet you can use your ladder safely even on uneven grounds.

A ladder should always be level to be safe when used. However, there are many occasions when you need to use a ladder on a sloping/uneven ground or on a surface with level differences. For your safety, we created the Adjustable Safety Feet. With our Adjustable Safety Feet assembled on the ladder, you can adjust the ladder-feet setting your ladder level and always feel safe when working.

The Adjustable Safety Feet with its unique inbuilt Ball Joint design, creates a safe and steady grip. The big rubber plates ensure extraordinary stability and touching ground under all circumstances. The Adjustable Safety Feet may also be supplemented with our Ground Spikes for extra good grip in muddy, snowy, or icy environments.

Our innovative Adjustable Safety Feet are beloved by many Telesteps customers and continue to inspire our team at Telesteps to take innovation another step further. Nothing should stand in the way of a safe quality ladder, regardless of its working environment.



Art. No.	9190-209
Max. height	220 mm
Foot	Ø155 mm x2
Joint	360°
Weight	1,5 kg

GROUND SPIKES

The base doesn't matter - snow, mud or dirt. Better grip is always close at hand.

This accessory is a complement to our Safety Foot and works safely even in the most extreme climates.

Useful and innovative products do not always need to be large and complicated. Like winter tires on a car, Telesteps Ground Spikes are providing stability and safety – even in the toughest environments.



Art. No.	9142-101
----------	----------

CARRY BAG

Nice and robust bag to carry the ladder in. It also protects the ladder.

Quality premium products should be treated as such. Just like a beautifully constructed car, Telesteps products need care. Our simple and portable products just got easier to carry with – in a bag around the shoulder, while it is always protected and ready for work.

Art. No. 9193-201



MAINTENANCE KIT

Be safe by taking care of your ladder.

For reasons of safety and functionality, the telescopic product must always be kept clean, particularly the telescopic tubes and rungs. Dirt, filings, paint spots, glue etc. must be cleaned after each use, and before the ladder is closed.

Treat your Telesteps products with care and it will retain its unique properties.

Art. No. 9205-101 (Professional)

Art. No. 9205-201 (Rescue)



SLIDE PROTECTOR

Get your ladder locked safely to the roof.

When you have a place where you regularly use your ladder a roof connector is a small investment for the added safety.

Art. No.

9211-101



INNOVATIONS ARE RUNNING THROUGH OUR VEINS

We are constantly improving our products and developing new accessories to make your life safer and easier.

Our colleagues from R&D at the headquarter in Tranås, Sweden are working hard every day to ensure you are getting the best and most efficient accessories for your Telesteps ladders.

Several new accessories have been launched during the past couple of years and there are much more to come...

HELP US HELP YOU

We are always striving to receive the best possible and most honest feedback from our customers and/or end-users. If you have an idea for a new accessory or the feeling that there is room for any kind of improvement, please do not hesitate to contact us!

SPARE PARTS

Replace to be safe.

Our high quality ensures a long lasting product. Very long lasting. This might cause parts to wear out and sometimes have to be replaced. Here you can find some of our spare parts easily to be assembled by yourself maintaining the highest level of safety.

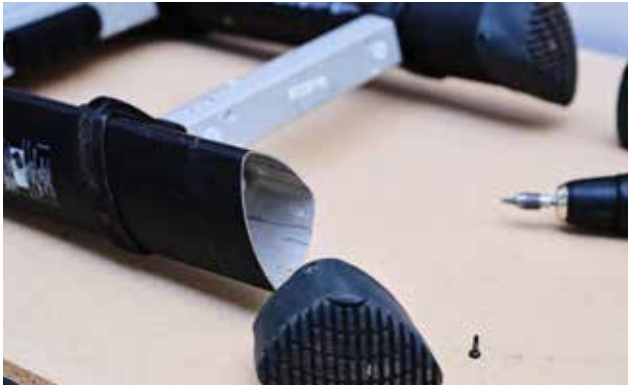

RUBBER FEET

Our angled rubber feet are created to provide the ladder with maximum surface contact. When used regularly and for a long period of time you might need to replace the rubber feet.

Art. No.	9514-101 Solid
	9514-521 Combi 2,3/3,0
	9550-521 Prime 3,0/3,2
	9551-521 Prime 3,5/3,8
	9552-521 Prime 4,1
	9568-501 Stabiliser bar



BRACKET KIT FOR AUTOLIFT

To replace the handle on older versions of Combi Line.

Art. No.	9220-101 Combi 2,3/3,0 (Round tube)
----------	-------------------------------------



RUBBER TOP

The rubber top prevents the ladder from slipping and damaging the wall. If they appear to be damaged/worn out, they could easily be replaced.

Art. No.	9553-521 Prime 3,2/3,8/4,1
	9567-521 Prime 3,0/3,5 & Combi 2,3/3,0

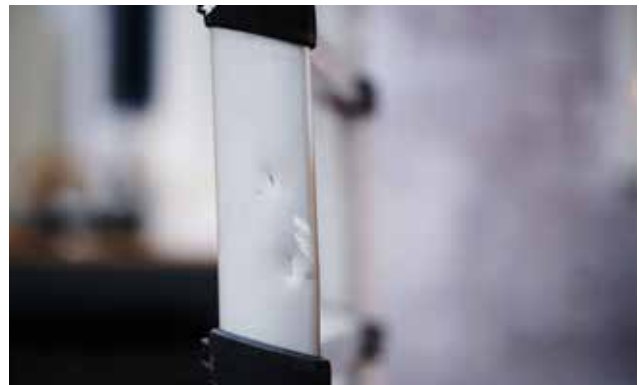

DAMAGED PARTS ON LADDER

If your ladder appears to have any damages, please do not use the ladder and contact your reseller to see what can be done to repair your ladder.



Many years ago, we created an icon in the world of ladders, and today we are recognized as the world leader in telescopic work tools.

With both R&D and world class production based in Sweden, the Telesteps brand and our products, are renowned for its quality and design, by many professional tradesmen worldwide ensuring we always put safety and quality first.



No.1 in telescopic work tools

Telesteps AB, Box 362, 573 24 Tranås, Sweden
info@telesteps.com | www.telesteps.com